



QUICKSILVER[®]

F I B R E G L A S S

*If You Like the Water
You'll Love Quicksilver*



www.marinepower.com

If You Like the Water You'll Love Quicksilver



Go boating and go have fun. And when you want the most fun on the water, Quicksilver has a boat that's just right for you.

Quicksilver has extended its range and 2002 is definitely a year of innovation. In addition to the 30 existing models, 4 new boats are now available – whether you are highly experienced or newly acquainted with the sea. Read on and discover the 425 Commander, the 500 Fish, the 550 WalkAround and the 635 Pilothouse. Different in style, different in size, but all with the right quality at the right price.

There are Quicksilver models for economical family cruising. Boats that let you fish, no matter what the weather might bring. Sporty craft, ideal for seeking the freedom of the water and exploring those far-away destinations. And Quicksilvers especially suited for boating beginners.

Depending on the Quicksilver model and personal choice, the power at your stern can be a high-performing, hard-working **Mercury** or **Mariner** four-stroke or two-stroke outboard, or a **Mercury MerCruiser**, the most popular sterndrive in history.



Improvements to most models of the Quicksilver range include a stylish new steering wheel, new electrical panel with indicator lights and extra switches for accessories, electric bilge pump with automatic / manual switch, new navigation lights, smooth action 4000 series remote controls, light bronze coloured plexiglas windshields, stainless steel cleats and improved boarding / swim ladders.

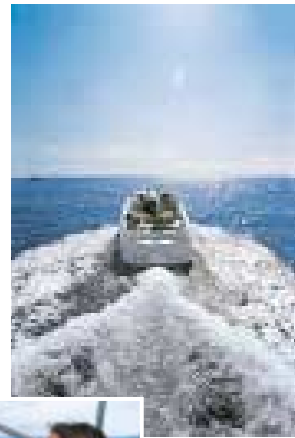

Whatever your choice, you'll be backed by a nationwide and international service dealer network — and by the biggest name in pleasure boating, **Mercury Marine**.





- 900 Commander ▶ 750 Commander ▶ ▶ ▶ 4/5
- 630 Commander ▶ 630 WalkAround ▶ ▶ ▶ 6/7
- 550 Commander ▶ 550 WalkAround ▶ ▶ ▶ 8/9
- 500 Commander ▶ 425 Commander ▶ ▶ ▶ 10/11
- Commander Series ▶ ▶ ▶ 12/13
- 650 Pilothouse ▶ 635 Pilothouse ▶ ▶ ▶ 14/15
- 620 Pilothouse ▶ 560 Pilothouse ▶ ▶ ▶ 16/17
- 500 Pilothouse ▶ Pilothouse Series ▶ ▶ ▶ 18/19
- 750 Cruiser ▶ 625 Cruiser ▶ ▶ ▶ 20/21
- 590 Cruiser ▶ 520 Cruiser ▶ ▶ ▶ 22/23
- 580 Open ▶ 520 Open ▶ 435 Open ▶ ▶ ▶ 24/25
- 500 Cabin ▶ 450 Cabin ▶ ▶ ▶ 26/27
- 420 Cabin ▶ 470 Sport ▶ ▶ ▶ 28/29
- 500 Fish ● 440 ▶ 400 ▶ 360 Barque ▶ ▶ ▶ 30/31

QUICKSILVER®

900 Commander & 750 Commander

Take the helm of a Commander

Commander: "To be the one in control." It's the dictionary's definition and it's the perfect description of Quicksilver's premium range of centre console boats. When you step on board, you immediately see why. The little touches like the teak trim, the stainless steel fittings, the fully instrumented dashboard. The boat carries the name, but when you take the helm, you're the one in Command.

The flagship of the Quicksilver range is the **900 Commander**, spacious, comfortable and with a long list of extras as standard. You'll have a wide-beam smile once you board the **900 Commander**, a walk-around boat designed for exceptional performance. The **900 Commander** is everything that a serious offshore fishing boat should be. Serious room to fish. Serious equipment for the professional. Serious outboard power.

Room to sleep 4 in two separate cabins makes overnight trips more relaxing – and you'll awaken more refreshed. With luck, you'll get up to the smell of freshly brewed coffee coming from the well equipped galley. You and your shipmates can enjoy it sitting around the built-in table in the forward cabin. A separate head adds a touch of comfort and sophistication – and is appreciated by the rest of the crew.

Bow rails sweep well aft of the wheelhouse to ensure a secure grip as you go forward for anchor duty or to fight the big one as he circles the boat.

Huge storage lockers provide place for all the gear you need – fenders, lines, anchor, buckets, boathooks, safety equipment - and of course your fishing gear. An overhead electronics pod has room for all the navigation gear you could need. And an overhead search light is standard equipment.

And when you idle into port after one of those long weekends on the water, you'll probably wonder if you really want to tie up at the dock, or just fill up the standard Igloo icechest and head back over the horizon.

The Quicksilver **900 Commander**. It's that kind of boat.



900 COMMANDER

900 Commander.
The fully equipped
galley is ready to cook
up the day's catch.



Specifications	900	750 i/b	750 o/b
Overall length (m)	8.55	7.85	7.35
Overall beam (m)	2.96	2.82	2.82
Draft (m)	0.45	0.54	0.52
Weight (kg)	2200	1950	1800
CE category	B	B	B
Number of people	9	7	7
Maximum power (HP)	450	300	300
Maximum power (kW)	336	224	224
Maximum engine weight (kg)	500	N/A	450



If you're looking for a serious offshore fishing boat, but don't need the size of the 900, the **750 Commander** is just for you. Outboard or sterndrive power. MerCruiser diesels or petrol. Single or twin. The **750 Commander** can be built in whatever configuration you want.

When you are headed far over the horizon, it's comforting to know that you have twin engines behind you. And with today's fuel prices, you'll be pleased with twin 4-stroke or Optimax outboards or twin MerCruiser sterndrives. It's your choice. And as an exclusive, the 750 Commander is available with dual MerCruiser 1.7 litre diesel sterndrives – MerCruiser's latest diesel offering. Of course if your cruising range is closer to port, there's no problem to install a single MerCruiser or outboard.



900 Commander & 750 Commander.
Like any serious fishing machine, there is a standard bait well with a seawater circulation pump.



750 COMMANDER

900 Commander & 750 Commander.
The serious fisherman will appreciate the 4 roof-mounted rod holders and the standard cockpit lights.

Equipment 900

Anchor Locker • Pulpit • Bench Seat • Locker for Icebox • Storage Lockers • Rod Locker • Cushions - Berths • Bow Sheave • Swim Ladder • Side Storage Compartment • Navigation Lights • Grab Rails • Opening Deck Hatch • Windshield • Teak Laminate Floor - Cockpit* • Bilge Pump • Fishing Rod Rack • Built-in Fuel Tank (585 litres) • Cockpit Upholstery • Co-Pilot Seat • Hydraulic Steering • Cleats • Chemical WC

Equipment 750

Anchor Locker • Pulpit • Bench Seat • Locker for Icebox • Storage Lockers • Cushions - Berths • Bow Sheave • Swim Ladder • Side Storage Compartment • Navigation Lights • Opening Deck Hatch • Windshield • Teak Laminate Floor - Cockpit* • Bilge Pump • Built-in Fuel Tank (300 litres) • Cockpit Upholstery • Co-Pilot Seat • Cockpit Cushions - Sun Deck** • Hydraulic Steering*** • Cleats • Chemical WC



900 Commander & 750 Commander.
There's no doubt that these are serious fishing boats. Hydraulic steering, binnacle mount engine controls, SmartCraft instrumentation, electronics pod, navigation chart holder, remote controlled search light. And that's just the beginning.

630 Commander & 630 WalkAround

Who says you can't have it all? The **630 WalkAround** is the perfect compromise. Loads of space on deck combined with cozy accommodations below. Romantic overnight trips and sun-filled days. If that's your dream, this is your boat.

The **630 Commander** has a centre console and is the perfect dayboat for those quick trips to a secluded cove. There's plenty of room around the picnic table up forward, or convert it into a sunpad when you or your passengers want to stretch out and relax. Fast yet safe, powerful yet economical.

Both versions of the 630 feature hydraulic steering as standard equipment for the easiest boat control possible.



630 COMMANDER



630 Commander.
A standard picnic table mounts ahead the stylish console.



630 Commander.
It features separate anchor and bow lockers for more storage; more functionality.



630 Commander.
A bow roller, recessed anchor line channel, in-line cleat and anchor locker are professional quality on the 630 series.

Specifications	630	630WA
Overall length (m)	6.25	6.25
Overall beam (m)	2.47	2.47
Draft (m)	0.35	0.35
Weight (kg)	830	900
CE category	C	C
Number of people	6	6
Maximum power (HP)	175	175
Maximum power (kW)	131	131
Maximum engine weight (kg)	215	215





630 WalkAround.

The cuddy cabin gives you plenty of storage room, plus true V-berths for 2 persons with standard cushions make overnight stays a real possibility. An overhead hatch provides daylight to the cabin.



630 Commander & 630 WalkAround. The aft seat hides more storage room and there is also storage under the cockpit floor and the Pilot and Co-pilot's chairs swivel and are adjustable fore and aft.

630 WalkAround.

Thanks to its generous beam, it features an extended width console for better protection, but still offers passage forward on both port and starboard side. If you are into skiing, be sure to order the optional ski pole.

630 WALKAROUND



Equipment 630

Anchor Locker • Pulpit • Bench Seat • Storage Lockers • Bow Sheave • Swim Ladder • Navigation Lights • Grab Rails • Ski Pole* • Windshield • Teak Laminate Floor - Cockpit* • Bilge Pump • Built-in Fuel Tank (155 litres) • Cockpit Upholstery • Co-Pilot Seat • Cockpit Cushions - Sun Deck • Hydraulic Steering • Picnic Table • Cleats • Chemical WC

Equipment 630 WalkAround

Anchor Locker • Pulpit • Bench Seat • Storage Lockers • Cushions - Berths • Bow Sheave • Swim Ladder • Side Storage Compartment • Navigation Lights • Grab Rails • Ski Pole* • Opening Deck Hatch • Windshield • Teak Laminate Floor - Cockpit* • Bilge Pump • Built-in Fuel Tank (145 litres) • Cockpit Upholstery • Co-Pilot Seat • Cockpit Cushions - Sun Deck • Hydraulic Steering • Cleats • Chemical WC

* Optional

550 Commander & 550 WalkAround

The 550 is the junior version of the 630 Commander. The same stylish looks, the same basic features. All the same functionality in a slightly smaller package. It's easy to trailer and easy to store when you're not using it.

The new 550 WalkAround features loads of storage room, rod holders, an optional ski pole, a swim ladder and a cabin for 2. This boat brings together all that is needed to leave harbour for a couple days, be it for a fishing trip, a skiing outing or for a romantic overnight cruise.



550 COMMANDER

550 Commander.
The helm is practical, comfortable and stylish. The wrap-around windshield helps to protect you and your passengers from the elements.



<i>Specifications</i>	550	550 WA
Overall length (m)	5.35	5.35
Overall beam (m)	2.28	2.28
Draft (m)	0.33	0.33
Weight (kg)	720	750
CE category	C	C
Number of people	6	5
Maximum power (HP)	115	115
Maximum power (kW)	86	86
Maximum engine weight (kg)	185	185



550 WALKAROUND



550 Commander.
The picnic table in the bow can be removed and stowed below in rough weather.



550 WalkAround.
A comfortable cabin with a pair of V-berths awaits the crew at the end of the day? or provides a cozy place the kids can call their own.



550 Commander & 550 WalkAround.
Teak gunwale inserts add a touch of elegance and provide both handholds and a place for the standard fishing rod holders.



550 Commander & 550 WalkAround.
If skiing is your thing, then be sure to order the optional ski pole!

Equipment 550

Anchor Locker • Pulpit • 2 Aft Seats • Storage Lockers • Bow Sheave • Swim Ladder • Navigation Lights • Grab Rails • Ski Pole* • Windshield • Teak Laminate Floor - Cockpit* • Bilge Pump • Built-in Fuel Tank (90 litres) • Cockpit Upholstery • Co-Pilot Seat • Cockpit Cushions • Sun Deck • Picnic Table • Cleats • Chemical WC

Equipment 550 WalkAround

Anchor Locker • Pulpit • 2 Aft Seats • Storage Lockers • Cushions - Berths • Bow Sheave • Swim Ladder • Side Storage Compartment • Navigation Lights • Grab Rails • Ski Pole* • Opening Deck Hatch • Windshield • Teak Laminate Floor - Cockpit* • Bilge Pump • Built-in Fuel Tank (90 litres) • Cockpit Upholstery • Co-Pilot Seat • Cleats • Chemical WC



550 WalkAround.
The 550 WA features easy forward access to the anchor locker with a well protected passage on the port side.

* Optional

500 Commander & 425 Commander

The **500 Commander** has become one of Quicksilver's hit models. It's hard to describe all of the features in this boat, but here are some of the things you can do with it: Fish, Cruise, Water-ski, Sunbathe, Explore, Picnic, Travel... How good is your imagination? And when you want to change activities, there's loads of storage room to put away what you're no longer using – there's even a special locker for fishing rods or water-skis.

The new **425 Commander** is a proud addition to the Commander family. Ideal for up to 4 people and perfect for water sports or family fun. There is more storage than you would expect, a sun pad is standard equipment and the raised bow rails ensure a safer grip when anchoring the boat and give more assurance when small children are onboard.



500 COMMANDER



500 Commander.
It's fun to gather around this fold-out picnic table when you take a pause in your cruise.



500 Commander.
Need to store your skis or need to store your fishing rod? Both will fit handily into this custom-built locker.



500 Commander.
When the sun shines, you can stretch out on this full size sunpad. When you're not using it, all the elements stow in purpose-built lockers.

Specifications	500	425
Overall length (m)	5.00	4.25
Overall beam (m)	2.20	2.10
Draft (m)	0.25	0.25
Weight (kg)	530	370
CE category	C	C
Number of people	5	4
Maximum power (HP)	75	50
Maximum power (kW)	56	37
Maximum engine weight (kg)	145	95





425 COMMANDER



425 Commander.
The standard sunpad lets you and your crew stretch out and enjoy the rays on sunny days.



425 Commander.
A convenient storage locker keeps your gear safe and dry.



425 Commander.
Teak laminate cockpit floor and gunwale inserts add a warm feeling to the 425 Commander.

Equipment 500

- Anchor Locker • Pulpit • Ski Locker • Storage Lockers • Rod Locker • Swim Ladder • Navigation Lights • Grab Rails • Windshield • Teak Laminate Floor - Cockpit • Bilge Pump • Built-in Fuel Tank (49 litres) • Cockpit Upholstery • Co-Pilot Seat • Cockpit Cushions - Sun Deck • Picnic Table • Cleats

Equipment 425

- Storage Lockers • Swim Ladder • Navigation Lights • Grab Rails • Windshield • Bilge Pump • Cockpit Upholstery • Co-Pilot Seat • Cockpit Cushions - Sun Deck • Cleats

Commander Series



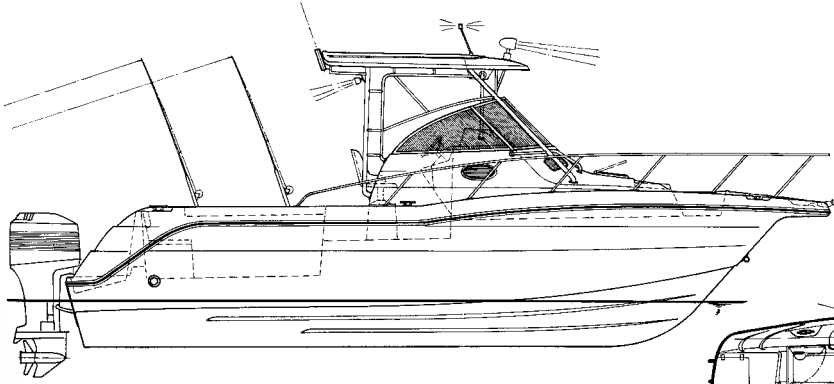

900 COMMANDER

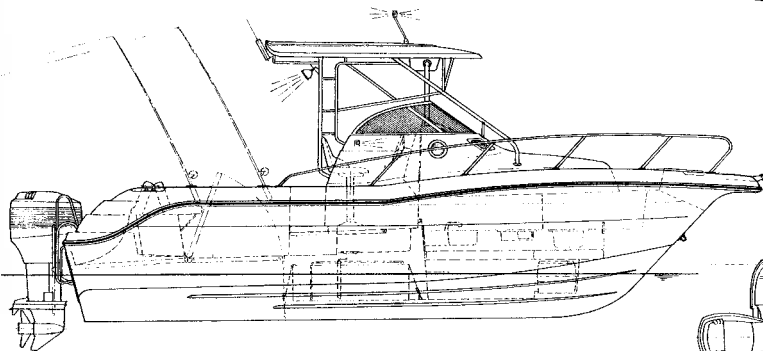
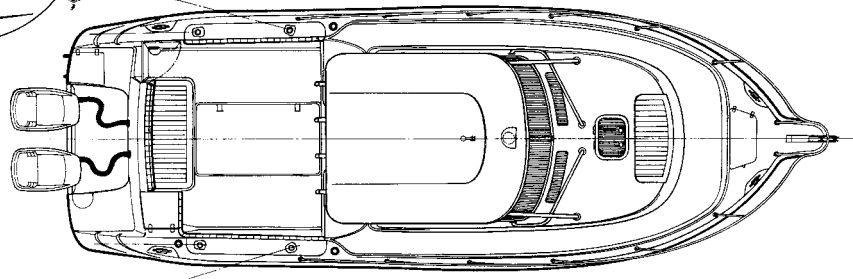

750 COMMANDER O/B

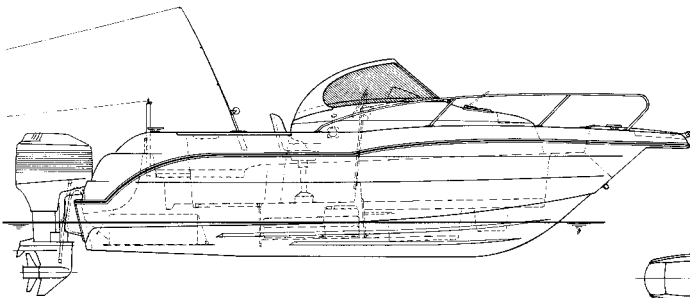
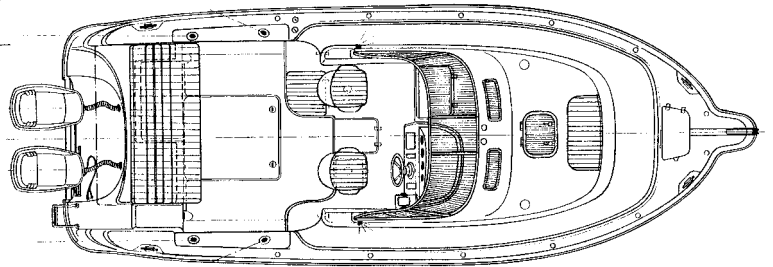

630 WALKAROUND

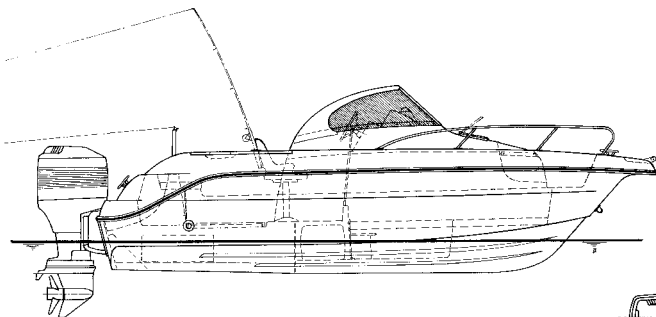
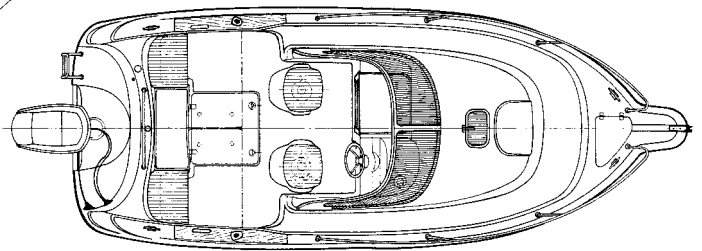

550 WALKAROUND

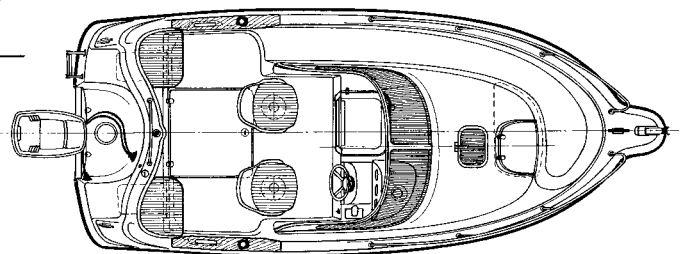

650 Pilothouse & 635 Pilothouse

Pilothouse : New adventures on the water

Quicksilver's Pilothouse range of spacious boats will take you out to the fish quickly and safely. Or if you prefer your boating pleasure with all the family, these are roomy boats with sturdy protection from the weather.

There are five models in the Pilothouse family, from the 500 through the well equipped 650. These boats will take you where you want to go with outboards from 40 to 115 horsepower.

The top-of-the-range 650 is like an apartment on the water. Plenty of room outside to fish, enjoy the scenery, have a sunny lunch. Plenty of room inside to relax if the weather turns rainy, prepare and have a warm meal, sleep overnight if you're far from your home port. An enclosed head for that extra touch of privacy.

The new 635 is one of the most comfortable fishing boats you can find. A modern design and new cabin layout make this boat an excellent choice for the week-end fisherman who wants more comfort than you can find on more utilitarian boats of a similar size. The 635 Pilothouse can take up to 90 HP of outboard four-stroke power but will run well with a 75.



650 PILOTHOUSE

650 Pilothouse.

The Pilot's chair flips up to reveal a freshwater sink. The galley also has a place for a cooker so the catch of the day can be prepared as soon as it's caught! If the weather is fine, eat in the open cockpit, or eat inside if it's more comfortable.



Specifications	650	635
Overall length (m)	6.50	6.35
Overall beam (m)	2.53	2.49
Draft (m)	0.42	0.42
Weight (kg)	1100	900
CE category	C	C
Number of people	6	6
Maximum power (HP)	115	90
Maximum power (kW)	86	67
Maximum engine weight (kg)	185	185





635 PILOTHOUSE



650 Pilothouse.
The spacious cabin includes a convertible dining table.



635 Pilothouse.
A generously sized sliding door separates the oversize cockpit from the cabin. Wooden gunwale inserts incorporate extra handholds and the standard bathing platform and boarding ladder make it easy to go for a swim on a sunny day.



635 Pilothouse.
The dining table converts to an extra berth and the portable head is neatly secured between the forward V-berths.



635 Pilothouse.
A compact galley - including a freshwater-supplied sink hidden under the skipper's seat - makes it easy to cook up the day's catch.

Equipment 650

Anchor Locker • Pulpit • Bench Seat • Storage Lockers • Table & Seat convertible to 3 Berths • Cushions - Berths • Bow Sheave • Swim Ladder • Side Storage Compartment • Navigation Lights • Grab Rails • Opening Deck Hatch • Windshield • Bilge Pump • Built-in Fuel Tank (120 litres) • Cockpit Upholstery • Picnic Table • Cleats • Chemical WC

Equipment 635

Anchor Locker • Pulpit • Bench Seat • Storage Lockers • Table & Seat convertible to 3 Berths • Cushions - Berths • Bow Sheave • Swim Ladder • Side Storage Compartment • Navigation Lights • Grab Rails • Opening Deck Hatch • Windshield • Bilge Pump • Built-in Fuel Tank (90 litres) • Cleats • Chemical WC

620 Pilothouse & 560 Pilothouse

Pure fishing machines. That's the best definition of the **Quicksilver 620** and **560 Pilothouse** models. When fishing is your passion, these boats are your craft. Any dyed-in-the-wool fisherman knows that his boat is as critical a piece of equipment as his fishing rod. If either one isn't up to the task, it puts the day's catch at risk. And there's hardly a greater disappointment than seeing a trophy fish get away because of substandard material. That's one thing that you won't have to worry about with these boats.



620 PILOTHOUSE

620 Pilothouse & 560 Pilothouse.
A standard bow roller and a well placed anchor locker make anchoring easy.

620 Pilothouse.
It permits overnight trips plus lots of storage room. Cockpit cushions are standard.

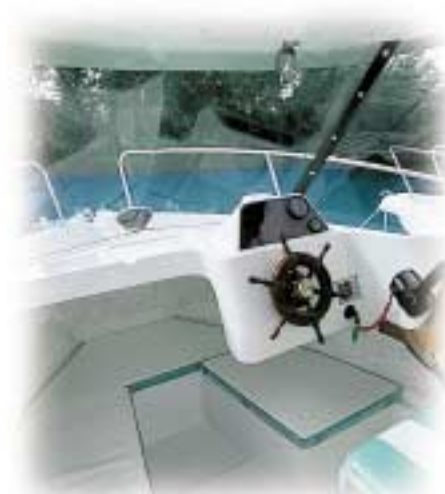

Specifications	620	560
Overall length (m)	6.20	5.60
Overall beam (m)	2.48	2.48
Draft (m)	0.45	0.45
Weight (kg)	850	840
CE category	C	C
Number of people	6	5
Maximum power (HP)	115	75
Maximum power (kW)	86	56
Maximum engine weight (kg)	185	185





560 PILOTHOUSE



560 Pilothouse.
The spoked wheel adds a nautical touch to this popular boat.



560 Pilothouse.
You have a great view from the helm. There's loads of storage space underneath the standard cushions.



560 Pilothouse.
It is a fisherman's dream. Big open cockpit, plus a place to shelter when the weather blows up.

Equipment 620

- Anchor Locker • Pulpit • Bench Seat • Storage Lockers • Cushions - Berths • Bow Sheave • Swim Ladder • Navigation Lights • Grab Rails • Opening Deck Hatch • Windshield • Bilge Pump • Built-in Fuel Tank (125 litres) • Cleats • Chemical WC*

Equipment 560

- Anchor Locker • Pulpit • Bench Seat • Storage Lockers • Cushions - Berths • Bow Sheave • Swim Ladder • Navigation Lights • Grab Rails • Opening Deck Hatch • Windshield • Bilge Pump • Built-in Fuel Tank (90 litres) • Cleats • Chemical WC*

* Optional

500 Pilothouse

When you're a demanding fisherman, but your requirements are for a compact Pilothouse boat, the Quicksilver 500 Pilothouse is the ideal choice. The clever design featuring an offset cabin means more room sheltered from the weather without giving up a secure portside passageway forward. A spacious fishing cockpit comes with more storage space than you would expect from a boat of this size.



500 PILOTHOUSE



500 Pilothouse.
The cleverly designed cockpit is set-off to starboard to give a good passage forward on the port side.



500 Pilothouse.
The airy cabin features loads of storage space plus a Pilot's seat which folds down for more driving comfort in rough weather.



500 Pilothouse.
There's plenty of storage in the two generous lockers on each side of the engine well.

Specifications 500

Overall length (m)	5.00
Overall beam (m)	2.35
Draft (m)	0.34
Weight (kg)	590
CE category	C
Number of people	5
Maximum power (HP)	75
Maximum power (kW)	56
Maximum engine weight (kg)	145

Pilothouse Series

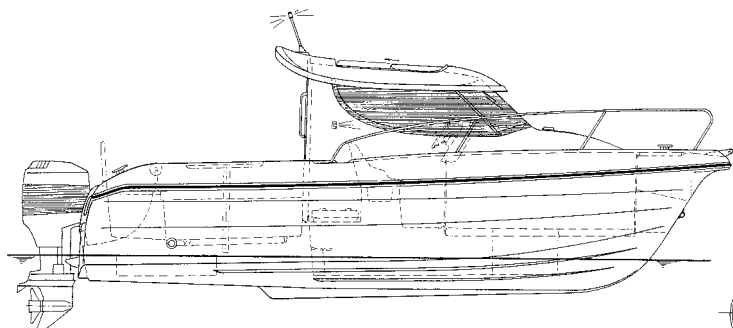

650 PILOTHOUSE

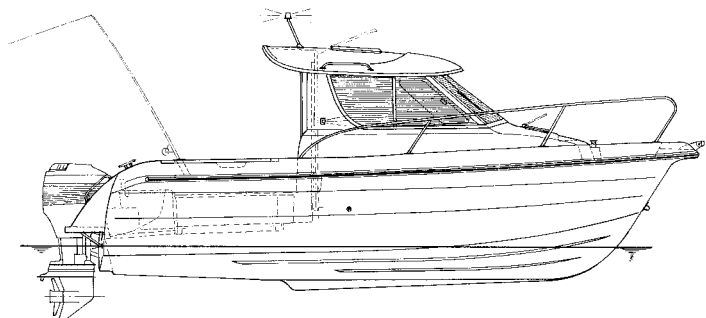
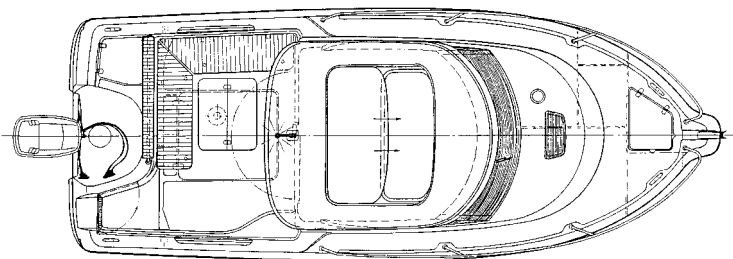

635 PILOTHOUSE

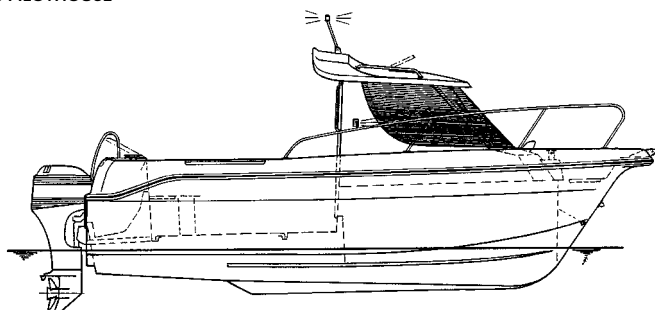
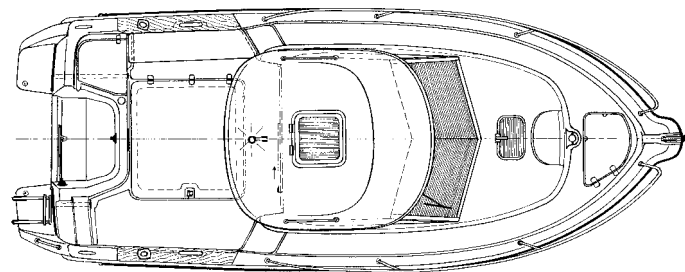

560 PILOTHOUSE

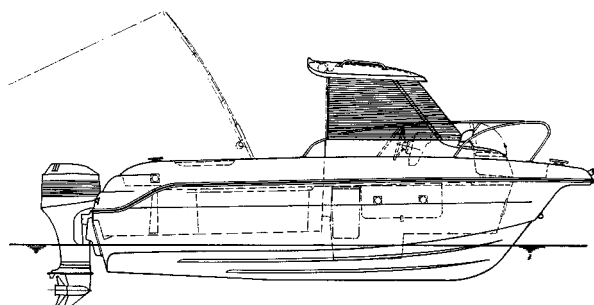
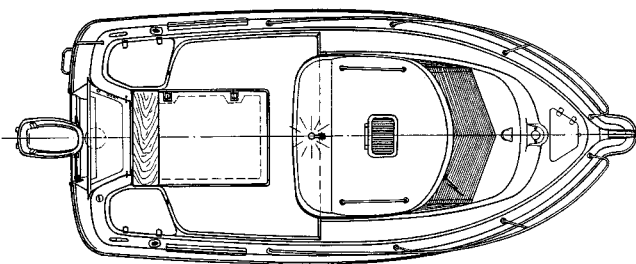

500 PILOTHOUSE

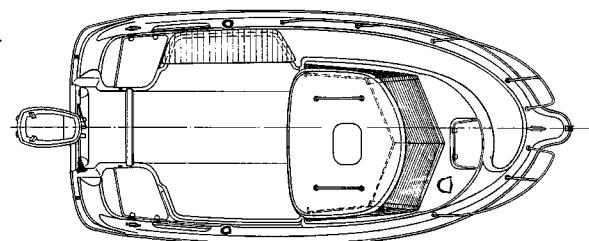

Equipment 500

Anchor Locker • Pulpit • Bench Seat • Storage Lockers
• Bow Sheave • Side Storage Compartment • Navigation
Lights • Grab Rails • Windshield • Bilge Pump • Cleats

750 Cruiser & 625 Cruiser

Take your pleasures in style. Day Cruisers

The pleasures of cruising across open water are at their best when your boat is a **Quicksilver Day Cruiser**.

Featuring the **750**; one of the most affordable cruising craft in this size category. In addition, the range features a **625**, a **590** and a **520** as well, – good-looking craft to take you to those distant shores.

The **750** – top of the Quicksilver's cruising range. With a spacious cabin featuring an enclosed head, a fully equipped galley and comfortable dining table which is convertible to twin berths, this boat is a great way to travel the coastline. The huge cockpit leaves plenty of room for sightseeing, fishing or having a relaxing meal. And standard Mercury MerCruiser power is fuel efficient and trouble-free so you can concentrate on what you want to do, not figuring out where the next fuel station is.

The **625** is a sporty pocket cruiser with reliable MerCruiser power. Choose the popular 4.3L MPI petrol engine or the thrifty new 1.7 diesel for real fuel savings. Water-skiing, sunbathing, nipping down the coast to that hidden beach. It's all possible.



625 CRUISER



625 Cruiser.
The vast sunpad converts from a comfortable back bench seat.

Specifications	750	625
Overall length (m)	7.85	6.25
Overall beam (m)	2.82	2.47
Draft (m)	0.52	0.40
Weight (kg)	1700	985
CE category	B	C
Number of people	7	6
Maximum power (HP)	300	260
Maximum power (kW)	224	194
Maximum engine weight (kg)	N/A	N/A





750 Cruiser.
It features reliable and economical Mercury MerCruiser sterndrive power.



750 Cruiser.
This fully equipped galley makes cooking at sea a pleasure.



625 Cruiser.
It features a well-lit spacious cabin with V-berths and storage.



750 Cruiser.
Its cabin is a cosy place when it's time to tie up for the night. The settee converts to a berth for 2.



625 Cruiser.
There's extra storage room under the cockpit floor plus easy access to the fuel tank.

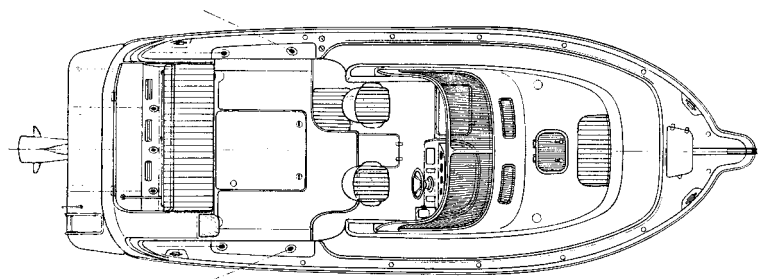
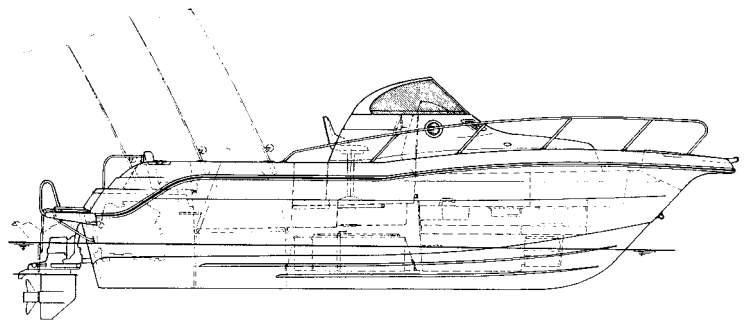

750 CRUISER

Equipment 750

- Anchor Locker • Pulpit • Bench Seat • Storage Lockers • Cushions - Berths • Bow Sheave • Swim Ladder • Side Storage Compartment • Navigation Lights • Opening Deck Hatch • Windshield • Bilge Pump • Built-in Fuel Tank (300 litres) • Cockpit Upholstery • Co-Pilot Seat • Cockpit Cushions - Sun Deck • Cleats • Chemical WC

Equipment 625

- Anchor Locker • Pulpit • Storage Lockers • Cushions - Berths • Bow Sheave • Swim Ladder • Side Storage Compartment • Navigation Lights • Opening Deck Hatch • Windshield • Bilge Pump • Built-in Fuel Tank (135 litres) • Cockpit Upholstery • Co-Pilot Seat • Cockpit Cushions - Sun Deck • Cleats • Chemical WC*

* Optional

590 Cruiser & 520 Cruiser

The **590 Cruiser** is the outboard version of the 625. It has all the same comforts of the 625 (see page 20) but a different power option. If your preference is for a Mercury or Marine Optimax outboard, then this is the Cruiser for you. If you don't need quite as much boat, but still enjoy the cruising lifestyle, then consider the **520 Cruiser**. Sunpad, accommodations below, a cockpit with enough room to fish, lounge or lunch – it has it all.



590 CRUISER



590 Cruiser.
Fishing, skiing, cruising – the large cockpit can handle it all.



590 Cruiser.
It features a well lit spacious cabin with V-berths and storage. Hydraulic steering is standard.

Specifications	590	520
Overall length (m)	5.85	5.20
Overall beam (m)	2.47	2.28
Draft (m)	0.40	0.33
Weight (kg)	920	630
CE category	C	C
Number of people	6	5
Maximum power (HP)	175	115
Maximum power (kW)	131	86
Maximum engine weight (kg)	215	185



520 CRUISER



520 Cruiser.
Its cabin provides both storage room and simple sleeping accommodations.



590 Cruiser.
If you are a water skier, be sure to order the optional ski mast.



520 Cruiser.
The roomy cockpit features a comfortable Captain's chair, storage below the deck and a big bench seat aft. It even comes with a sunpad for those warm and relaxing days.

Equipment 590

- Anchor Locker • Pulpit • Storage Lockers • Cushions - Berths
- Bow Sheave • Swim Ladder • Side Storage Compartment •
- Navigation Lights • Ski Pole* • Opening Deck Hatch • Windshield
- Bilge Pump • Built-in Fuel Tank (135 litres) • Cockpit Upholstery •
- Co-Pilot Seat • Cockpit Cushions - Sun Deck • Hydraulic Steering •
- Cleats • Chemical WC*

Equipment 520

- Anchor Locker • Pulpit • Storage Lockers • Cushions - Berths •
- Bow Sheave • Swim Ladder • Navigation Lights • Opening Deck
- Hatch • Windshield • Bilge Pump • Built-in Fuel Tank (90 litres) •
- Cockpit Upholstery • Co-Pilot Seat* • Cockpit Cushions - Sun Deck
- Cleats • Chemical WC*

* Optional

580 Open, 520 Open & 435 Open

Style, performance, value. Open Series

Great looking boats with plenty of space and outstanding value for money. You'll love their performance as ski boats, as diving platforms or for going fishing with your friends. They carve up the water with ease and you'll thoroughly enjoy their smooth, steady handling characteristics.

The 580 and 520 are the European interpretation of the classic American bow-rider. Built specifically for our waters and our boating lifestyles, these boats have become classics in their own right. Easy maintenance all-fiberglass cockpits can be hosed down after a day on a sunny beach. No carpets to catch grit and sand – it all flushes out the scuppers. A generous sunpad on the aft deck converts to seating for your guests and the high freeboard is reassuring when you have small children on board.

If you need a functional open transportation boat, then the 435 is your choice. Loads of open room and a functional console make this boat a real workhorse. Which doesn't mean that it isn't fun. After all, there's no reason that you can't throw out a fishing line or sneak up on a quiet beach with this little boat.



580 OPEN



580 Open & 520 Open. Both the 520 Open (shown) and the 580 Open feature a central ski locker.



580 Open. The walkthrough windshield makes it easy to get to the bow seating area. Hydraulic steering is standard.

Specifications	580	520	435
Overall length (m)	5.90	5.20	4.25
Overall beam (m)	2.48	2.28	1.85
Draft (m)	0.38	0.33	0.25
Weight (kg)	850	610	300
CE category	C	C	C
Number of people	6	5	4
Maximum power (HP)	175	115	40
Maximum power (kW)	131	86	30
Maximum engine weight (kg)	215	185	85





520 OPEN



520 Open.
The twin consoles shelter both the driver and the co-pilot.



435 Open.
It is a simple boat for quick trips and easy maintenance.



435 OPEN



520 Open.
Its back seat converts to a sunpad.

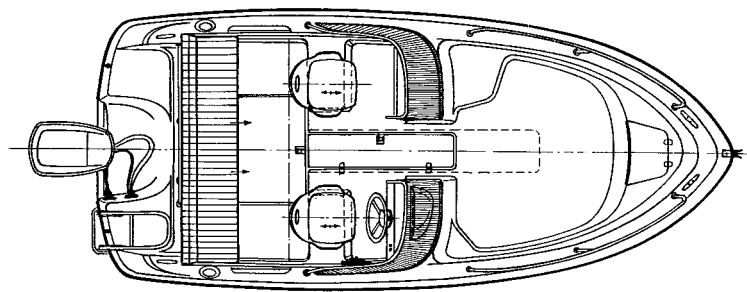
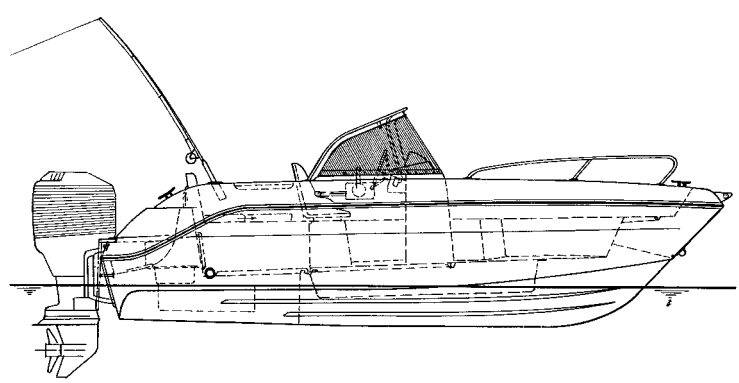

520 OPEN

Equipment 580

- Anchor Locker • Ski Locker • Storage Lockers • Bow Sheave • Swim Ladder • Navigation Lights • Grab Rails • Ski Pole* • Windshield • Bilge Pump • Fishing Rod Rack • Built-in Fuel Tank (133 litres) • Cockpit Upholstery • Co-Pilot Seat • Cockpit Cushions - Sun Deck • Hydraulic Steering • Cleats

Equipment 520

- Anchor Locker • Pulpit • Bench Seat • Ski Locker • Storage Lockers • Bow Sheave • Swim Ladder • Navigation Lights • Grab Rails • Windshield • Bilge Pump • Built-in Fuel Tank (90 litres) • Cockpit Upholstery • Co-Pilot Seat • Cockpit Cushions - Sun Deck • Cleats

Equipment 435

- Anchor Locker • Bench Seat • Storage Lockers • Grab Rails • Windshield • Bilge Pump • Co-Pilot Seat • Cleats

* Optional

500 Cabin & 450 Cabin

Fun for all the family. Cabin Series

Hardy fun boats with a cabin in which to change clothing or simply relax, Quicksilver's Cabin series make ideal family boats. From the 500, a spacious, passenger-friendly craft with plenty of extras as standard, to the 450, Quicksilver's classic best-seller, to the amazingly compact, yet complete 420, there's a cabin model sure to meet your needs. All feature cockpit storage, driver and passenger cockpit seating and lockable storage in the forecabin. All have anchor lockers – not always a common feature on boats of this size.

The seat of Quicksilver 500 Cabin cleverly covers a watertight storage compartment, maximizing room in the cockpit, while on the 450, the driver's seat folds out of the way when it's time to open up the cockpit for some serious fishing. On both boats, the portside bench seat can be removed to give more fishing access to the side of the boat.



500 Cabin.
The helm with the pilot's seat
and storage compartment.

500 CABIN



500 Cabin.
Standard fishing rod holders.

Specifications	500	450
Overall length (m)	5.00	4.48
Overall beam (m)	2.35	2.10
Draft (m)	0.34	0.32
Weight (kg)	550	400
CE category	C	C
Number of people	5	5
Maximum power (HP)	90	40
Maximum power (kW)	67	30
Maximum engine weight (kg)	145	85





450 CABIN



450 Cabin.
It is the perfect low maintenance fishing boat. Easy to use, simple to maintain.



450 Cabin.
The pilot's seat folds out of the way.



500 Cabin.
The bow roller makes raising and lowering the anchor easy.

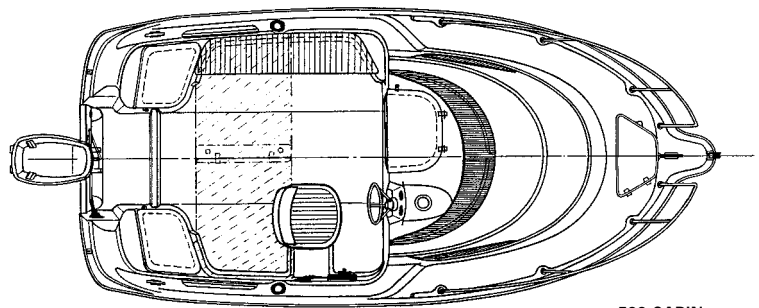
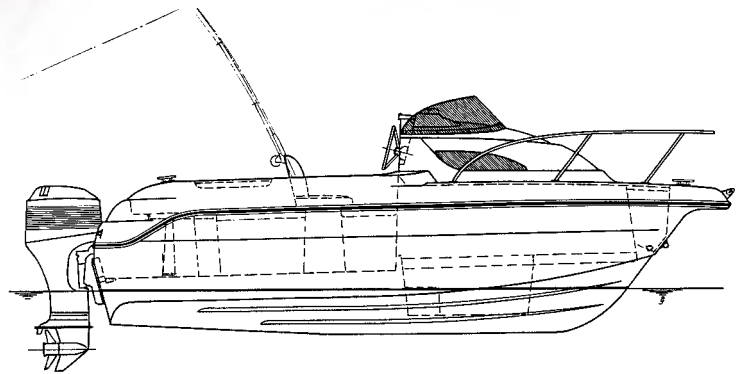

500 CABIN

Equipment 500

- Anchor Locker • Pulpit • Bench Seat • Storage Lockers
- Cushions - Berths • Bow Sheave • Navigation Lights
- Grab Rails • Windshield • Bilge Pump • Cleats

Equipment 450

- Anchor Locker • Pulpit • Bench Seat • Storage Lockers
- Cushions - Berths • Navigation Lights • Grab Rails •
- Windshield • Bilge Pump • Cleats

420 Cabin

For lots of fun in a small package, the 420 can't be beat. For coastal cruises, a little trolling fishing or just a favourite boat for potting about, the 420 is an ideal little package. And it's as practical as it is fun: Easy to tow behind the smallest car, easy to store and economical to operate. A true little ship that's a great way to begin boating – or to stay boating – if you don't need a larger craft.



420 CABIN



420 Cabin.
Stylish and affordable, it is a great introduction to the world of boating.

420 Cabin.
Two generous storage compartments aft for fuel tank and gear.



420 Cabin.
With 2 V-berths, you can even overnight!

Specifications	420 C	470 S
Overall length (m)	4.20	4.65
Overall beam (m)	1.95	2.08
Draft (m)	0.31	0.30
Weight (kg)	370	420
CE category	C	C
Number of people	4	4
Maximum power (HP)	40	90
Maximum power (kW)	30	67
Maximum engine weight (kg)	85	145

470 Sport

Sporty fun in an affordable package.

If you're looking for a compact sportboat, look no further. Skiing, cruising, or just checking out the beaches. This boat does it all. Like similar bigger craft, the 470 features a walk-through windshield for easy access to the foredeck and the anchor locker, back-to-back seating which convert to sunpads and make it easy to watch a skier, a ski locker in the cockpit floor and a clean, modern design. But unlike many similar larger boats, the 470 is easy to tow, easy to maintain and easy to store. It comes standard with a quality canvas boat cover so when you're ready to go for a spin, the inside will be clean and dry.



470 SPORT



470 Sport.
Ski locker, under deck storage,
walkthrough windshield. It has it all.

Equipment 420

Anchor Locker • Pulpit • Bench Seat • Storage Lockers • Cushions - Berths • Side Storage Compartment • Navigation Lights • Grab Rails • Windshield • Bilge Pump • Cleats

Equipment 470 Sport

Anchor Locker • Ski Locker • Storage Lockers • Side Storage Compartment • Navigation Lights • Ski Pole* • Windshield • Bilge Pump • Built-in Fuel Tank (60 litres) • Cockpit Upholstery • Co-Pilot Seat • Cockpit Cushions - Sun Deck • Cleats • Mooring Cover

* Optional

500 Fish

The new 500 Fish – a boat of Scandinavian inspiration – brings the range a touch of tradition. With a spacious and beamy cockpit, the 500 Fish can carry up to 6 people. It features 2 midship benches with hidden storage, an anchor locker plus a second forward equipment locker, stainless steel cleats, stern lockers and comes standard with 2 storage positions for an optional Igloo ice chest. It can take up to a 60 hp outboard and is also available without the steering console if you prefer a tiller-steered engine.



500 FISH

500 Fish.
A special place has been designed to stow the optional Igloo 54 ice-chest so you can keep your catch cool or your lunch warm.



500 Fish.
The 500 Fish is available with or without a steering console.

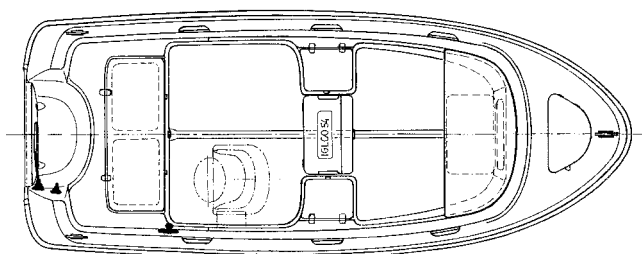
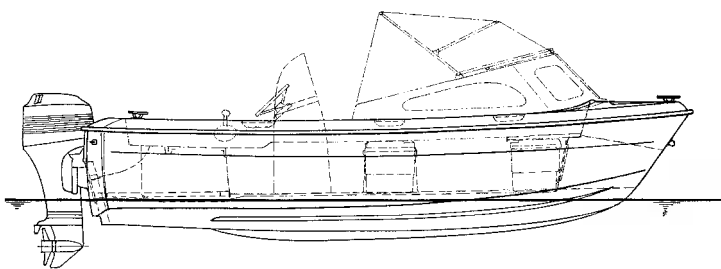

500 FISH

Specifications	500 F	440	400	360
Overall length (m)	5.00	4.40	4.05	3.62
Overall beam (m)	2.00	1.80	1.60	1.67
Draft (m)	0.35	0.25	0.15	0.15
Weight (kg)	400	260	155	110
CE category	C	C	D	D
Number of people	6	4	4	3
Maximum power (HP)	60	25	20	10
Maximum power (kW)	44	19	15	7.4
Maximum engine weight (kg)	120	55	55	40



440 Barque, 400 Barque & 360 Barque

Lightweight and long lasting.

For relaxation and fun afloat there's a Quicksilver Barque just for you. Tough and built to last, they'll take an outboard engine or are light enough for you to use a pair of oars. There's seating fore, aft and amidships and, depending on the model, they'll accommodate up to five people. A great way to start boating.



440 Barque.
4 generous lockers provide storage for even the most demanding boater.



400 Barque.
Stow your fuel tank, extra lines and even your fishing tackle in the 400 Barque's aft locker.

360 BARQUE

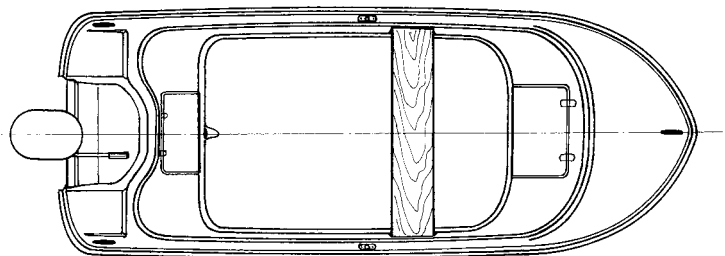
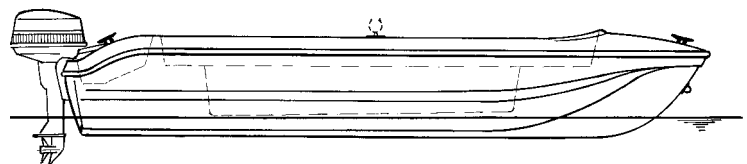

400 BARQUE

Equipment 500 Fish

Anchor Locker • Storage Lockers • Console* • Cleats

Equipment 440 Barque

Bench Seat • Storage Lockers • Cleats

Equipment 400 Barque

Bench Seat • Storage Lockers • Cleats

Equipment 360 Barque

Oars • Bench Seat • Storage Lockers

* Optional

The very best in engine power

Every Quicksilver boat comes with a Mercury or Mariner outboard or a sterndrive from Mercury MerCruiser. These are market-leading outboards and sterndrives from the world's largest pleasure boat engines group, Mercury Marine.

Depending on the boat model you choose, the power package can be a four-stroke, two-stroke or OptiMax direct-injection outboard, or a petrol or diesel Mercury MerCruiser with Alpha or Bravo drive.

You'll have the very best and most up-to-the-minute engine power to take your boat out to enjoy the delights of the water.

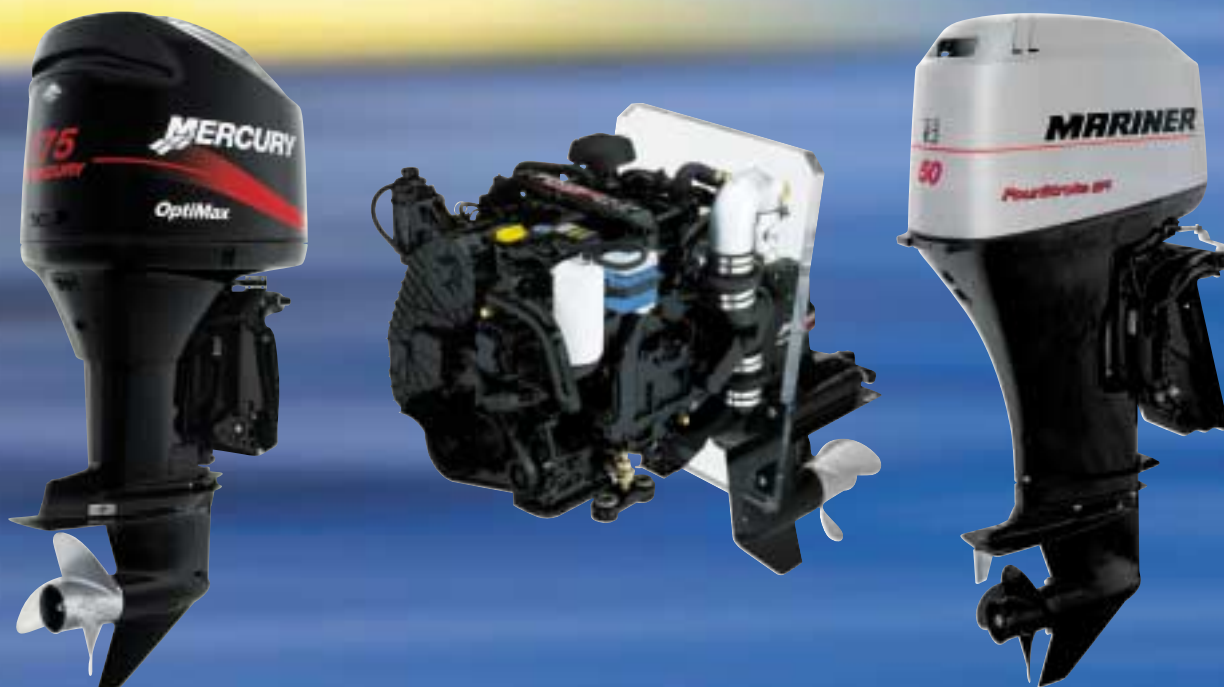

QUICKSILVER

www.marinepower.com

Remember – life vests float. You don't. Always use your engine's safety stop lanyard.

© M.P.E. 2001 PPH GB PRINTED IN BELGIUM 90-877781-02

Mercury Marine continuously explores means to improve the products it designs, manufactures and distributes. Changes to the specifications of its engines, boats and accessories are ongoing. Every effort is made to produce sales and service literature which is current. This brochure should not be regarded as a precise guide to the latest specifications. This brochure is also not an offer for sales of any particular engine, boat, or accessory. Distributors and dealers are not agents of Mercury Marine and they have no authority to bind Mercury Marine by any express undertaking or representation, including but not limited to representations of a product, sales, applications, or service nature.

Not all boats are available in all countries. Some boats shown in this catalogue are equipped with optional accessories. Please see with your local dealer.